

Preliminary Datasheet SGP40

Indoor Air Quality Sensor for VOC Measurements

- MOx based gas sensor for indoor air quality applications
- Outstanding long-term stability and lifetime
- I²C interface with digital output signal
- Very small 6-pin DFN package: 2.44 x 2.44 x 0.85 mm³
- Low power consumption: 2.6 mA at 3.3 V
- Tape and reel packaged, reflow solderable

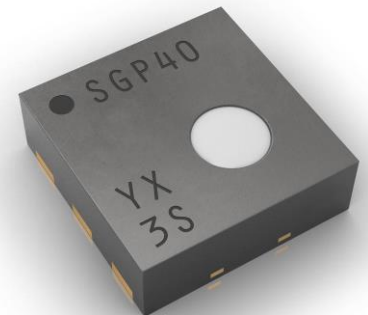

Product Summary

The SGP40 is a digital gas sensor designed for easy integration into air purifiers or demand-controlled ventilation systems. Sensirion's CMOSens[®] technology offers a complete, easy-to-use sensor system on a single chip featuring a digital I²C interface and a temperature-controlled micro hotplate, providing a humidity-compensated VOC based indoor air quality signal. The output signal can be directly processed by Sensirion's powerful VOC Algorithm to translate the raw signal into a VOC Index as a robust measure for indoor air quality. The VOC Algorithm automatically adapts to the environment the sensor is exposed to. Both sensing element and

VOC Algorithm feature an unmatched robustness against contaminating gases present in real-world applications enabling a unique long-term stability as well as low drift and device-to-device variation. The very small 2.44 x 2.44 x 0.85 mm³ DFN package enables applications in limited spaces. Sensirion's state-of-the-art production process guarantees high reproducibility and reliability. Tape and reel packaging together with suitability for standard SMD assembly processes make the SGP40 predestined for high-volume applications.

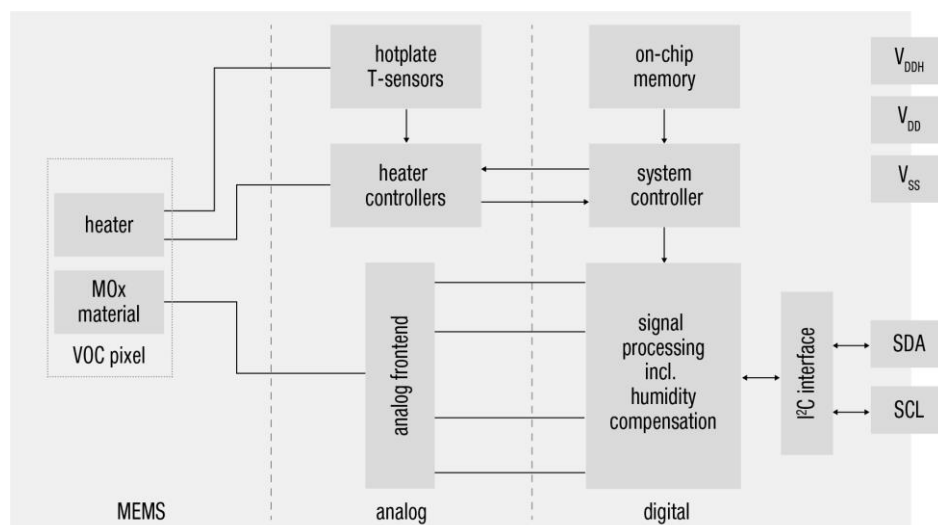

Figure 1 Functional block diagram of the SGP40.

Table of Contents

1 Sensor Performance.....	3
2 Specifications.....	5
3 Sensor Output Signal Description.....	9
4 Digital Interface Description.....	11
5 Mechanical Specifications	15
6 Ordering Information.....	17

1 Sensor Performance

Table 1 lists specifications characterizing the gas sensing performance. The SGP40 chip provides a digital raw signal (SRAW) which is sensitive to all VOC gases typically present in indoor environments and which is proportional to the logarithm of the resistance of the MOx material. This signal is intended for further processing by an algorithm providing quantitative information about the VOC based indoor air quality. For this purpose, Sensirion offers its robust VOC Algorithm, which is included in the VOC Index driver package available on Sensirion's webpage.¹ The algorithm maps all VOC and fresh air events to a VOC Index scale (see application note *SGP40 – VOC Index for Experts* for more details). For the specifications given below, ethanol in clean air has been used as proxy gas for typical indoor air events.

Parameter	Comments	Values ²			Units	
		Min.	Typ.	Max.		
Output signals ³	Digital processed value (VOC Index)	0	–	500	VOC Index points	
	Digital raw value (SRAW)	0	–	65'535	ticks ⁴	
Measurement range	Ethanol in clean air	0	–	1'000	ppm	
Specified range	Ethanol in clear air	0.3	–	30	ppm	
Device-to-device variation	VOC Index ⁵	–	<±15 <±15	–	VOC Index points or % VOC Index m.v. (the larger)	
Repeatability	VOC Index ⁵	–	<±5 <±5	–	VOC Index points or % VOC Index m.v. (the larger)	
Limit of detection ^{6,7}	Ethanol in specified range	–	–	<50 <10	ppb or % of concentration setpoint (the larger)	
Response time	Changing concentration from 5 to 10 ppm of ethanol, at sampling interval of 1 s	τ ₆₃	–	<10	–	s
		τ ₉₀	–	<30	–	s
Switch-on behavior	Time until reliably detecting VOC events ⁸	–	<60	–	s	
	Time until specifications in this table are met	–	<1	–	h	
Sensitivity ⁷	SRAW, doubling VOC concentration	Ethanol in specified range	–	–870	–	ticks
		5 to 10 ppm of ethanol	–710	–870	–1'030	ticks
Recommended sampling interval	VOC Index	–	1	–	s	
	SRAW	10	1	0.5	s	

Table 1 Gas sensing specifications at 25 °C and 50 % RH in zero air (considered as clean air for indoor air quality applications) and a power supply of V_{DD} of 3.3 V. All concentrations refer to ethanol as test gas.

¹ Download the *VOC Index Driver Package SGP40* on <https://www.sensirion.com/en/download-center/gas-sensors/multi-pixel-gas-sensors/>.

² 99.99 % of the sensors will be within the minimum–maximum tolerance corresponding to 4σ assuming a normal distribution. Typical tolerance refers to the mean of the distribution for ≥100 sensors.

³ Humidity compensated when actual humidity value is provided as input to the sensor (see section 3.1 Raw Signal Measurement).

⁴ Signal in ticks is proportional to the logarithm of the resistance of the sensing layer.

⁵ Evaluated using the calibration and test sequence according to the application note *SGP40 – Testing Guide*.

⁶ Limit of detection is defined as the minimum change of concentration required to obtain a raw signal change 3 times higher than the noise at the given concentration setpoint.

⁷ Parameter tested over simulated lifetime of 10 years in an indoor environment. Test conditions: continuous operation in 250 ppm of Decamethylcyclopentasiloxane (D5).

⁸ Signal increase during 60-s event of 5 to 10 ppm of ethanol is three times larger than signal drift without this event during the same duration.

Figure 2 displays the typical response of the raw signal of SGP40 to various VOCs as a function of their concentrations in otherwise clean air.

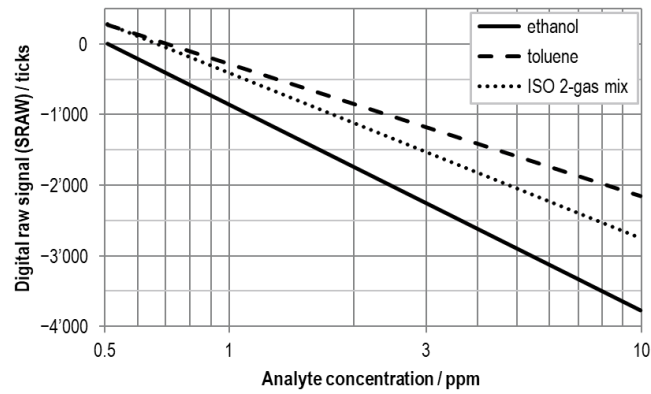

Figure 2 Typical sensor response to various VOCs normalized to 500 ppb of ethanol. Data were recorded at 25 °C and 50 % RH and a power supply of V_{DD} of 3.3 V.

2 Specifications

2.1 Electrical Specifications

Table 2 lists electrical specifications of the SGP40. Default conditions of 25 °C and 3.3 V supply voltage apply to values in the table below, unless otherwise stated. The SGP40 supports both I²C “standard-mode” and “fast-mode”.⁹

Parameter	Symbol	Values			Unit	Comments
		Min.	Typ.	Max.		
Supply voltage, hotplate supply voltage ¹⁰	V _{DD} , V _{DDH}	1.7	3.3	3.6	V	Minimal voltage must be guaranteed also for the maximum supply current specified in this table. V _{DD} and V _{DDH} must be connected to the same power supply, see Figure 5 .
Idle current	I _{DD}	–	34	105	µA	The idle mode is activated after power-up, after calling the <i>sgp40_heater_off</i> command, or after a soft reset.
Supply current under operation ¹¹		–	3.5	4.0	mA	Average current consumption while the sensor is continuously operated at V _{DD} , V _{DDH} = 1.8 V.
		–	2.6	3.0	mA	Average current consumption while the sensor is continuously operated at V _{DD} , V _{DDH} = 3.3 V.
Communication	–	Digital 2-wire interface, I ² C				

Table 2 Electrical specifications.

2.2 Timing Specifications

Timings in **Table 3** refer to the power up and reset of the ASIC part and do not reflect the usefulness of the readings.

Parameter	Symbol	Condition	Min.	Typ.	Max.	Unit
Power-up time	t _{PU}	After hard reset, V _{DD} ≥ V _{POR}	–	0.4	0.6	ms
Soft reset time	t _{SR}	After soft reset	–	0.4	0.6	ms
SCL clock frequency	f _{SCL}	–	–	–	400	kHz

Table 3 System timing specifications.

2.3 Recommended Operating and Storage Conditions

Gas Sensing Specifications as detailed in **Table 1** are guaranteed only when the sensor is stored and operated under the recommended conditions as specified in **Table 4** and displayed in **Figure 3** and **Figure 4**. Prolonged exposure to conditions outside these conditions may reduce sensor performance. The sensor must not be exposed towards condensing conditions (*i.e.*, >90 % relative humidity) at any time.

⁹ http://www.nxp.com/documents/user_manual/UM10204.pdf

¹⁰ Any supply voltage as defined by the min./max. range may be used for continuous operation of the sensor. The typical value specifies the supply voltage at which outgoing quality control is performed.

¹¹ Sending the *sgp40_measure_raw* command enables continuous operation of the sensor. A 20 % higher current is drawn during 5 ms on V_{DDH} after entering the measurement mode.

Condition	Parameter	Min.	Max.	Unit
Operating conditions	Relative humidity	0	90	% RH
	Temperature	-10	50	°C
Operating conditions of humidity compensation	Humidity	1.5 (-13)	30 (+31) 90 (the smaller)	g m^{-3} (°C dew point) or % RH
	Temperature	-10	50	°C
Storage conditions	Relative humidity	0	80	% RH
	Temperature	5	30	°C

Table 4 Recommended humidity and temperature conditions for storing and operating the SGP40. Dew point refers to maximum humidity allowed at minimum and maximum temperature, respectively.

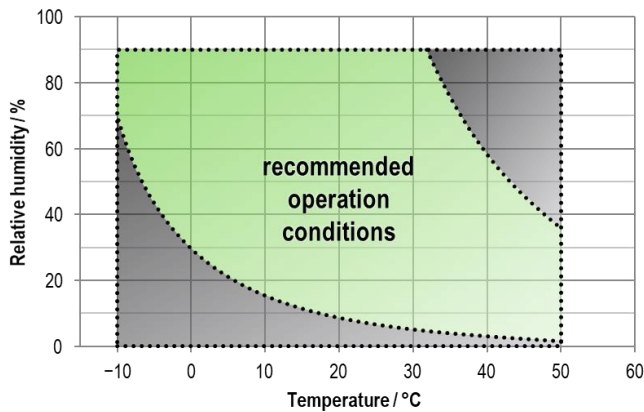

Figure 3 Recommended relative humidity and temperature for operating the SGP40. Green area marks conditions for which humidity compensation has been optimized. Additionally, gray areas mark operating conditions without using the humidity compensation feature.

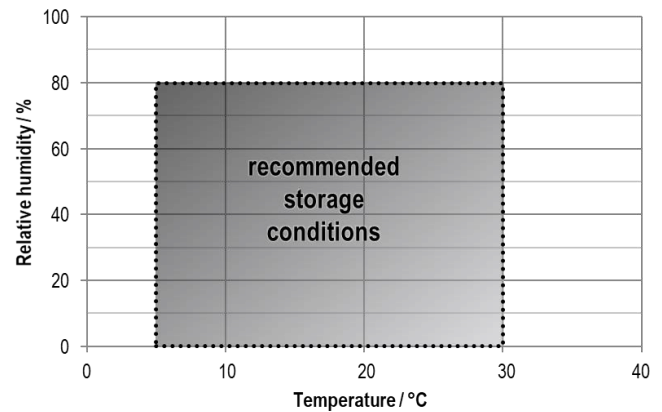

Figure 4 Recommended relative humidity and temperature for storing the SGP40.

To ensure an optimal performance of the SGP40, *Handling and Assembly Instructions for SGPxx Gas Sensors* as well as the *Design-in Guide for Integrating SGP4x Gas Sensors* need to be followed.

2.4 Absolute Minimum and Maximum Ratings

Stress levels beyond those listed in **Table 5** may cause permanent damage to the device. Exposure to minimum/maximum rating conditions for extended periods may affect sensor performance and reliability of the device.

Parameter	Rating
Supply voltage V_{DD}	-0.3 to +3.6 V
Supply voltage V_{DDH}	-0.3 to +3.6 V
Short-term storage temperature range ¹²	-40 to +70 °C
Operating temperature range	-20 to +55 °C
Short-term storage humidity range ¹²	0 to 80 % (non-condensing)
Operating humidity range	0 to 90 % (non-condensing)
ESD HBM	2 kV
ESD CDM	500 V
Latch up, JEDEC Class II, 125 °C	100 mA

Table 5 Absolute minimum and maximum ratings.

2.5 Interface Specifications

The SGP40 comes in a 6-pin DFN package, see **Table 6**. **Figure 5** shows a typical application circuit. The V_{DD} pin must be decoupled with an RC element. The required decoupling for V_{DDH} depends on the power supply network connected to the sensor, a capacitor of 1 μ F is recommended. V_{DD} and V_{DDH} must be connected to one single supply V_{DD} . The external pull-up resistors (e.g., $R_p = 10$ k Ω) are required to pull the SDA and SCL signal lines high. For dimensioning resistor sizes please take bus capacity and communication frequency into account (see section 7.1 of NXP's I²C Manual for more details, see footnote 9 on page 5). It should be noted that pull-up resistors may be included in I/O circuits of microcontrollers. The die pad or center pad is electrically connected to GND. Hence, electrical considerations do not impose constraints on the wiring of the die pad. However, for mechanical stability it is recommended to solder the die pad to the PCB.

Pin	Name	Comments
1	V_{DD}	Supply voltage
2	V_{SS}	Ground
3	SDA	Serial data, bidirectional
4	n/a	Connect to ground (no electrical function)
5	V_{DDH}	Supply voltage, hotplate
6	SCL	Serial clock, bidirectional

Table 6 Pin assignment (transparent top view). Dashed lines are only visible from the bottom.

¹² Short-term storage refers to temporary conditions during, e.g., transport.

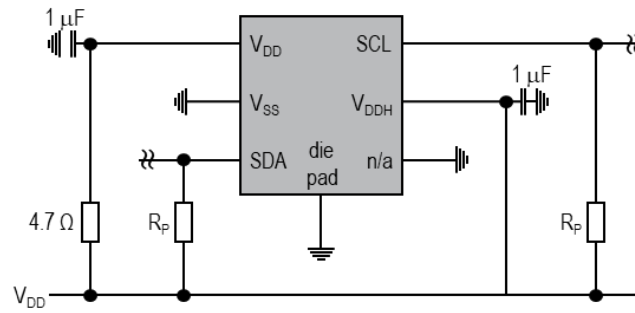

Figure 5 Typical application circuit.

2.6 Environmental Stability

The SGP40 has been qualified based on the JEDEC JESD47 qualification test method. The Moisture Sensitivity Level classification of the SGP40 is MSL1, according to IPC/JEDEC J-STD-020. At the same time, it is recommended to further process the sensors within 1 year after date of delivery. The SGP40 should not be exposed to bright illumination by either sunlight or artificial light sources during operation.

2.7 Material Contents

The device is fully RoHS, REACH, Halogen-free, and WEEE compliant, e.g., free of Pb, Cd, and Hg.

3 Sensor Output Signal Description

3.1 Raw Signal Measurement

Calling the *sgp40_measure_raw* command launches/continues the VOC measurement mode. It starts one measurement of the raw signal (SRAW) which is returned after 30 ms. Raw signal value in ticks is provided as one 16-bit word followed by one CRC byte (**Figure 6**). The raw signal in ticks is proportional to the logarithm of the sensor resistance. This signal is used as input for Sensirion's VOC Algorithm to provide a processed VOC Index (see section 3.2 VOC Index Measurement).

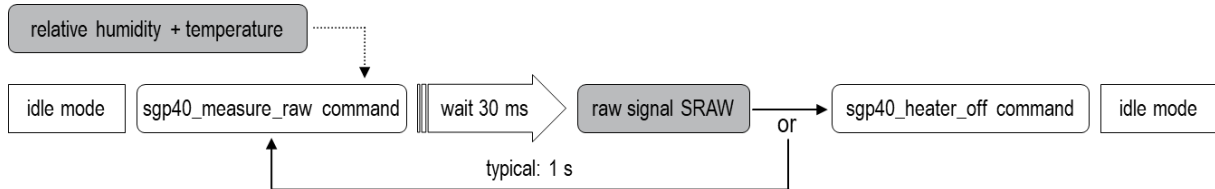

Figure 6 Process flow for performing a raw signal measurement with the SGP40. For enabling on-chip humidity compensation, current relative humidity and temperature values have to be supplied as part of the measurement command.

The SGP40 features an automatic on-chip humidity compensation of the raw signal. The feature remains disabled as long as default values for both humidity and temperature are sent together with the *sgp40_measure_raw* command. For enabling the compensation, the measurement command includes two words (+ respective CRC bytes) where the first word represents the relative humidity and the second one represents the temperature. Calling the *sgp40_heater_off* command stops the VOC measurement mode, switches off the hotplate, and puts the sensor in idle mode.

3.2 VOC Index Measurement

For best performance in indoor-air-quality use cases, Sensirion recommends processing the (humidity-compensated) raw signal SRAW through Sensirion's powerful VOC Algorithm. The VOC Algorithm (**Figure 7**) automatically adapts its output to any indoor environment and maps all VOC events to a VOC Index scale ranging from 0 to 500 VOC Index points (**Figure 8**). The value 100 refers to the typical indoor gas composition over the past 24 h. While values between 100 and 500 indicate a deterioration, values between 0 and 100 inform about improvement of the air quality. The VOC Algorithm is included in the VOC Index driver package available on Sensirion's webpage (see footnote 1 on page 3). SGP40 raw signal needs to be provided to the VOC Algorithm at a sampling rate of 1 Hz.

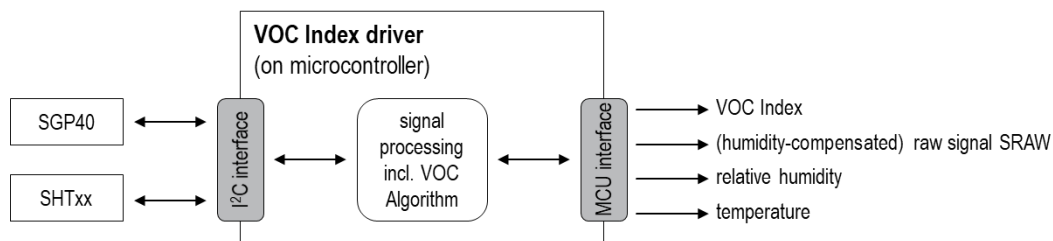

Figure 7 Schematic of the VOC Index driver.

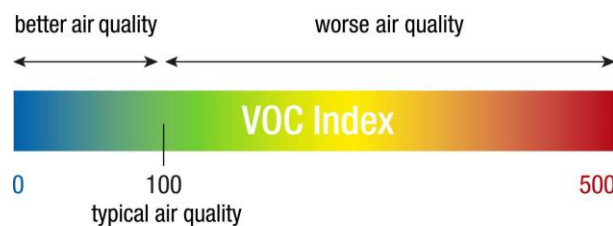

Figure 8 Explanation of the VOC Index.

3.3 Built-in Self-Test

With the `sgp40_measure_test` command, users can perform an on-chip self-test for, e.g., in-line or end-of-line production testing. If this command is called when the sensor is in idle mode, the sensor returns to idle mode after the test (**Figure 9**). In case this command is called during VOC measurement mode (i.e., after calling the `sgp40_measure_raw` command), the hotplate remains switched on thereafter. After 250 ms, the master can read a fixed data pattern (1 word + CRC byte) to check if the test was successful or not.

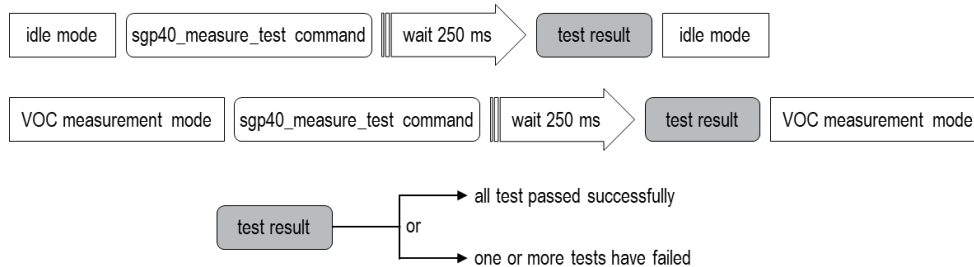

Figure 9 Possible ways of integrating the built-in self-test function.

3.4 Sensor Start-up Behavior

The sensor starts powering-up after reaching the power-up threshold voltage of 1.7 V and enters idle mode after max. 0.6 ms. In this state, the sensor is ready to receive commands from the master.

4 Digital Interface Description

4.1 General Considerations

For driver integration incl. utilization of Sensirion’s VOC Algorithm, please refer to the application note *SGP40 Driver Integration (for Dedicated I²C Hardware)*. All SGP40 commands consist of two bytes (16 bits). The commands must not be followed by a CRC. Additionally, data sent to and returned from the sensor is transferred in packets of two bytes (16 bits) followed by a 1-byte (8 bit) CRC.

4.2 I²C Address

The sensor’s I²C address is 89 (decimal; hex.: 0x59). The I²C header is formed by the I²C address followed by a read or write bit.

4.3 I²C Voltage Levels

The sensor’s interface is compatible with 1.7–3.6 V I²C bus voltage levels depending on the supply voltage level.

4.4 I²C Protocol Speed

The sensor supports I²C “standard-mode” and “fast-mode”, with a maximum clock frequency of 100 or 400 kHz, respectively (see footnote 9 on page 5).

4.5 I²C Sequences

The typical communication sequence between the I²C master (e.g., a microcontroller in a host device) and the sensor is described as follows and visualized in **Figure 10**:

1. The sensor is powered up
2. The I²C master periodically calls the measurement command and reads data in the following sequence:
 - a. I²C master sends a measurement command.
 - b. I²C master waits until the measurement is finished either by waiting for the maximum execution time or by waiting for the expected duration and then poll data until the read header is acknowledged by the sensor (expected durations are listed in **Table 8**).
 - c. I²C master reads out the measurement result.

With the acknowledgement of the measurement command, the SGP40 starts measuring. When the measurement is in progress, no communication with the sensor is possible and the sensor aborts the communication with a NACK condition. After the sensor has completed the measurement, the master can read the measurement results by sending an I²C read header. The sensor will acknowledge the reception of the read header and responds with data. The response data length is listed in **Table 8** and is structured in data words, where one word consists of two bytes of data (most significant bit first) followed by an one-byte CRC checksum. Each byte must be acknowledged by the master with an ACK condition for the sensor to continue sending data. If the sensor does not receive an ACK from the master after any byte of data, it will not continue sending data.

After receiving the checksum for the last word of data, a NACK and STOP condition have to be sent (see **Figure 10**). The I²C master can abort the read transfer with a NACK followed by a STOP condition after any data byte if it is not interested in subsequent data, e.g., the CRC byte or following data bytes, in order to save time. Note that the data cannot be read more than once, and access to data beyond the specified amount will return a pattern of high bits.

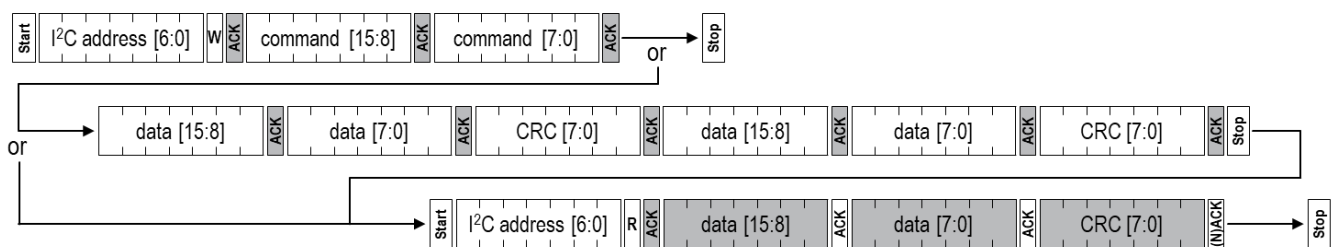

Figure 10 Possible I²C command sequences for communicating with the SGP40. Dark areas indicate that the sensor controls the SDA (data) line. First, the I²C master sends the write header writing a 16-bit command, potentially followed by two words of data with CRC bytes. For reading the measured data, the I²C master sends the read header and receives one word of data with CRC byte.

4.6 Checksum Calculation

The 8-bit CRC checksum transmitted after each data word is generated by the CRC algorithm according to the properties as stated in **Table 7**. The CRC covers the contents of the two previously transmitted data bytes.

Property	Value	Example code
Name	CRC-8	<pre>uint8_t CalcCrc(uint8_t data[2]) { uint8_t crc = 0xFF; for(int i = 0; i < 2; i++) { crc ^= data[i]; for(uint8_t bit = 8; bit > 0; --bit) { if(crc & 0x80) { crc = (crc << 1) ^ 0x31u; } else { crc = (crc << 1); } } } return crc; }</pre>
Width	8 bit	
Protected Data	read and/or write data	
Polynomial	0x31 ($x^8 + x^5 + x^4 + 1$)	
Initialization	0xFF	
Reflect input	False	
Reflect output	False	
Final XOR	0x00	
Examples	CRC (0xBE EF) = 0x92	

Table 7 Checksums are used for the 2-byte data packets only. The command codes themselves already contain a 3-bit CRC and therefore, a checksum must not be appended.

4.7 I²C Commands

The available measurement commands of the SGP40 are listed in **Table 8**.

Command	Command hex. code	Parameter length including CRC [bytes]	Response length including CRC [bytes]	Measurement duration [ms]	
				Typ.	Max.
<i>sgp40_measure_raw</i>	0x26 0F	6	3	25	30
<i>sgp40_measure_test</i>	0x28 0E	–	3	240	250
<i>sgp40_heater_off</i>	0x36 15	–	–	0.1	1

Table 8 I²C commands available for SGP40.

Measure Raw Signal

Command	Subcommand	Command hex. code	Description
<i>sgp40_measure_raw</i>	Without humidity compensation	0x26 0F 80 00 A2 66 66 93	This command starts/continues the VOC measurement mode, leaves humidity compensation disabled by sending the default values (see Table 10), and returns the measured raw signal SRAW as 2 bytes (+ 1 CRC byte).
	With humidity compensation	0x26 0F XX XX XX YY YY YY	This command starts/continues the VOC measurement mode, enables humidity compensation, and returns the measured raw signal SRAW as 2 bytes (+ 1 CRC byte). The humidity compensation feature requires a relative humidity XX XX XX and temperature YY YY YY input (incl. corresponding CRC bytes) in the format as given in Table 10 .

Table 9 Description of the I²C measurement command.

	Relative Humidity		Temperature	
	Value / %	Hex. code	Value / °C	Hex. code
Conversion into ticks	$RH/ticks = RH/\% \times \frac{65'535}{100}$		$T/ticks = (T/^\circ C + 45) \times \frac{65'535}{175}$	
Default	50	0x80 00 + CRC 0xA2	25	0x66 66 + CRC 0x93
Minimum	0	0x00 00 + CRC 0x81	-45	0x00 00 + CRC 0x81
Maximum	100	0xFF FF + CRC 0xAC	130	0xFF FF + CRC 0xAC

Table 10 Conversion of relative humidity in % and temperature in °C into ticks as the input parameters of the measurement command. Note: minimum and maximum values do not reflect the range of conditions for which the humidity compensation feature has been optimized. For details see **Table 4**.

Byte number	Description	Value
0, 1	two bytes	u16 unsigned integer directly provides the raw signal SRAW in ticks which is proportional to the logarithm of the resistance of the sensing element.
2	CRC byte for bytes 0, 1	–

Table 11 Returned values by the I²C measurement command.

Built-in Self-Test

Command	Command hex. code	Description
<i>sgp40_measure_test</i>	0x28 0E	This command triggers the built-in self-test checking for integrity of both hotplate and MOX material and returns the result of this test as 2 bytes (+ 1 CRC byte).

Table 12 Description of the I²C built-in self-test command.

Byte number	Description	Value
0, 1	two bytes	0xD4 00: all tests passed successfully 0x4B 00: one or more tests have failed
2	CRC byte for bytes 0, 1	–

Table 13 Returned values by the I²C built-in self-test command.

Return to Idle Mode

Command	Command hex. code	Description
<i>sgp40_heater_off</i>	0x36 15	This command turns the hotplate off and stops the measurement. Subsequently, the sensor enters the idle mode.

Table 14 Description of the I²C heater off command.

Soft Reset

Command	Command hex. code	Description
<i>soft_reset</i>	0x00 06	This command is a general call resetting all devices connected to the same I ² C bus. The first byte refers to the general call address and the second byte refers to the reset command. After calling this command, the SGP40 will restart entering the idle mode.

Table 15 Description of the I²C general soft reset command.

5 Mechanical Specifications

SGP40 sensors are provided in a DFN (dual flat no leads) package with an outline of $2.44 \times 2.44 \times 0.85 \text{ mm}^3$ and a terminal pitch of 0.8 mm. The sensor opening with a typical diameter of 0.8 mm is offset to the bottom right corner on the top side of the package. The sensor chip is assembled on a Ni/Pd/Au plated copper lead frame. Sensor chip and lead frame are over-molded by a black, epoxy-based mold compound. Please note that the side walls of the package are diced and therefore the lead frame sidewall surfaces are not plated.

5.1 Traceability

All SGP40 sensors are laser marked for easy identification and traceability (**Figure 11**). The marking on the sensor top side consists of a pin-1 indicator and three lines of text. The top line consists of the pin-1 indicator which is located in the top left corner and the product name. The two lines at the bottom consist of 2 alphanumeric digits each. That code can be decoded by Sensirion only and allows for tracking on batch level through production, calibration, and testing – and will be provided upon justified request.

If viewed from below pin 1 is indicated by triangular shaped cut in the otherwise rectangular die pad. The dimensions of the triangular cut are shown in **Figure 12**, right. The sensor opening on the top side is not recommended for optical alignment.



Figure 11 Top view of the SGP40 illustrating the laser marking.

5.2 Package Outline

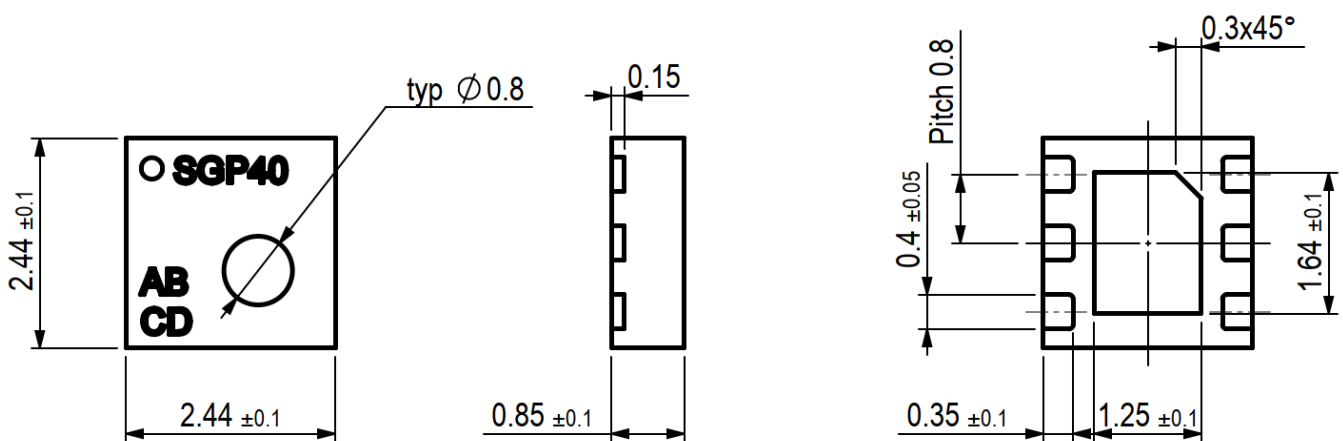

Figure 12 Package outline drawing of the SGP40. Dimensions are given in millimeters.

5.3 Land Pattern

Recommended land pattern of the SGP40 is shown in **Figure 13**. Pads on PCB are recommended to be non-solder mask defined (NSMD). Recommended solder paste stencil thickness is 125–150 μm .

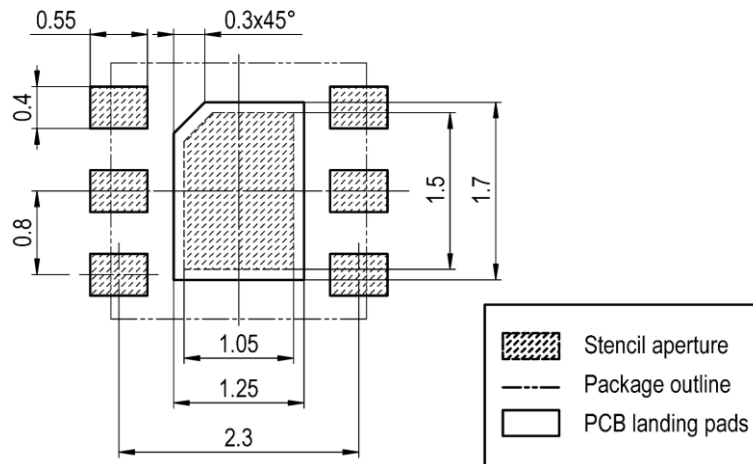

Figure 13 Recommended land pattern.

5.4 Soldering Instructions

Standard reflow soldering ovens and “no clean” type 3 solder paste (as specified in IPC J-STD-005A) should be used for soldering the SGP40. The sensors are designed to withstand a soldering profile according to IPC/JEDEC J-STD-020. Peak temperatures of $T_P = 245\text{ }^\circ\text{C}$ during up to $t_p = 30\text{ s}$ for Pb-free assembly in IR/Convection reflow ovens (see **Figure 14**) are recommended. In addition, we also recommend a maximum ramp-down rate of $<4\text{ }^\circ\text{C s}^{-1}$. Vapor phase or manual soldering should not be used in order to avoid damaging of the sensor. In case the PCB hosting the SGP40 chip passes through multiple solder cycles, it is recommended to assemble the SGP40 during the last solder cycle. Board wash and ultrasonic cleaning should be avoided. For general information (such as conformal coating), please also refer to the *Handling and Assembly Instructions for SGPxx Gas Sensors*.

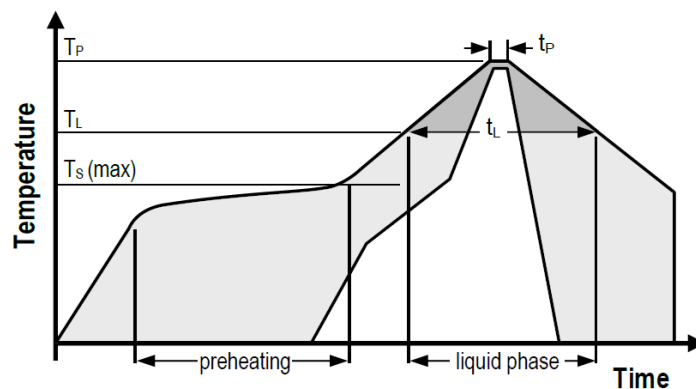

Figure 14 Soldering profile according to JEDEC standard. Recommended conditions are $T_P = 245\text{ }^\circ\text{C}$ and $t_p \leq 30\text{ s}$ for Pb-free assembly, $T_L < 220\text{ }^\circ\text{C}$ and $t_L < 150\text{ s}$. Ramp-up rate $<3\text{ }^\circ\text{C s}^{-1}$ and ramp-down rate $<4\text{ }^\circ\text{C s}^{-1}$.

6 Ordering Information

Use the part names and product numbers shown in the following table when ordering the SGP40 gas sensor and accessories. For the latest product information and local distributors, visit www.sensirion.com.

Part Name	Description	Ordering size	Product Number
SGP40-D-R4	SGP40 sensor components as tape on reel	2'500 pcs	3.000.384

Table 16 SGP40 ordering options.

6.1 Packaging Information

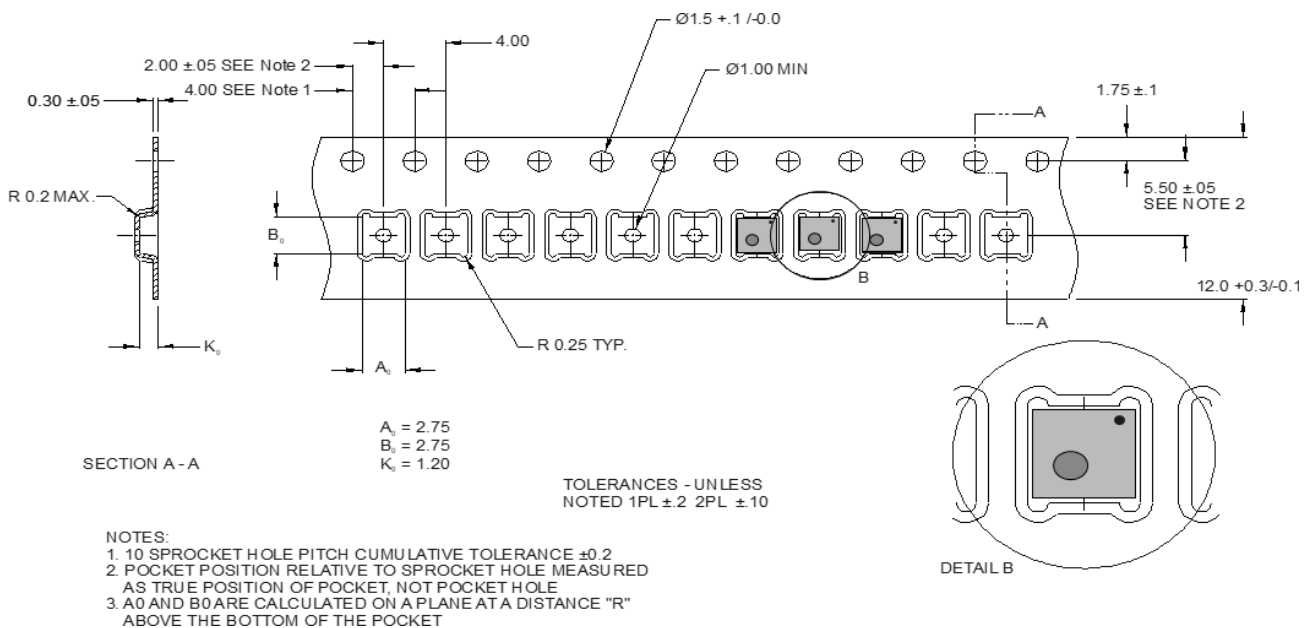

Figure 15 Technical drawing of the packaging tape with sensor orientation in tape. Header tape is to the right and trailer tape to the left on this drawing. Dimensions are given in millimeters.

Important Notices

Warning, Personal Injury

Do not use this product as safety or emergency stop devices or in any other application where failure of the product could result in personal injury. Do not use this product for applications other than its intended and authorized use. Before installing, handling, using or servicing this product, please consult the data sheet and application notes. Failure to comply with these instructions could result in death or serious injury.

If the Buyer shall purchase or use SENSIRION products for any unintended or unauthorized application, Buyer shall defend, indemnify and hold harmless SENSIRION and its officers, employees, subsidiaries, affiliates and distributors against all claims, costs, damages and expenses, and reasonable attorney fees arising out of, directly or indirectly, any claim of personal injury or death associated with such unintended or unauthorized use, even if SENSIRION shall be allegedly negligent with respect to the design or the manufacture of the product.

ESD Precautions

The inherent design of this component causes it to be sensitive to electrostatic discharge (ESD). To prevent ESD-induced damage and/or degradation, take customary and statutory ESD precautions when handling this product. See application note "ESD, Latchup and EMC" for more information.

Warranty

SENSIRION warrants solely to the original purchaser of this product for a period of 12 months (one year) from the date of delivery that this product shall be of the quality, material and workmanship defined in SENSIRION's published specifications of the product. Within such period, if proven to be defective, SENSIRION shall repair and/or replace this product, in SENSIRION's discretion, free of charge to the Buyer, provided that:

- notice in writing describing the defects shall be given to SENSIRION within fourteen (14) days after their appearance;
- such defects shall be found, to SENSIRION's reasonable satisfaction, to have arisen from SENSIRION's faulty design, material, or workmanship;
- the defective product shall be returned to SENSIRION's factory at the Buyer's expense; and
- the warranty period for any repaired or replaced product shall be limited to the unexpired portion of the original period.

This warranty does not apply to any equipment which has not been installed and used within the specifications recommended by SENSIRION for the intended and proper use of the equipment. EXCEPT FOR THE WARRANTIES EXPRESSLY SET FORTH HEREIN, SENSIRION MAKES NO WARRANTIES, EITHER EXPRESS OR IMPLIED, WITH RESPECT TO THE PRODUCT. ANY AND ALL WARRANTIES, INCLUDING WITHOUT LIMITATION, WARRANTIES OF MERCHANTABILITY OR FITNESS FOR A PARTICULAR PURPOSE, ARE EXPRESSLY EXCLUDED AND DECLINED.

SENSIRION is only liable for defects of this product arising under the conditions of operation provided for in the data sheet and proper use of the goods. SENSIRION explicitly disclaims all warranties, express or implied, for any period during which the goods are operated or stored not in accordance with the technical specifications.

SENSIRION does not assume any liability arising out of any application or use of any product or circuit and specifically disclaims any and all liability, including without limitation consequential or incidental damages. All operating parameters, including without limitation recommended parameters, must be validated for each customer's applications by customer's technical experts. Recommended parameters can and do vary in different applications.

SENSIRION reserves the right, without further notice, (i) to change the product specifications and/or the information in this document and (ii) to improve reliability, functions and design of this product.

Copyright© 2020, by SENSIRION.

CMOSens® is a trademark of Sensirion

All rights reserved

Revision History

Date	Version	Page(s)	Changes
July, 2020	1.0	All	Initial release

Headquarters and Subsidiaries

Sensirion AG

Laubisruetistr. 50
CH-8712 Staefa ZH
Switzerland

phone: +41 44 306 40 00
fax: +41 44 306 40 30
info@sensirion.com
www.sensirion.com

Sensirion Taiwan Co. Ltd

phone: +886 3 5506701
info@sensirion.com
www.sensirion.com

Sensirion Inc., USA

phone: +1 312 690 5858
info-us@sensirion.com
www.sensirion.com

Sensirion Japan Co. Ltd.

phone: +81 3 3444 4940
info-jp@sensirion.com
www.sensirion.com/jp

Sensirion Korea Co. Ltd.

phone: +82 31 337 7700~3
info-kr@sensirion.com
www.sensirion.com/kr

Sensirion China Co. Ltd.

phone: +86 755 8252 1501
info-cn@sensirion.com
www.sensirion.com/cn

To find your local representative, please visit
<http://www.sensirion.com/distributors>