

7SEMI

ESP32-S3 EC200U 4G

LTE Manual

(Cat-1 WiFi Bluetooth GNSS IoT Smart Modem)

Version 1.0

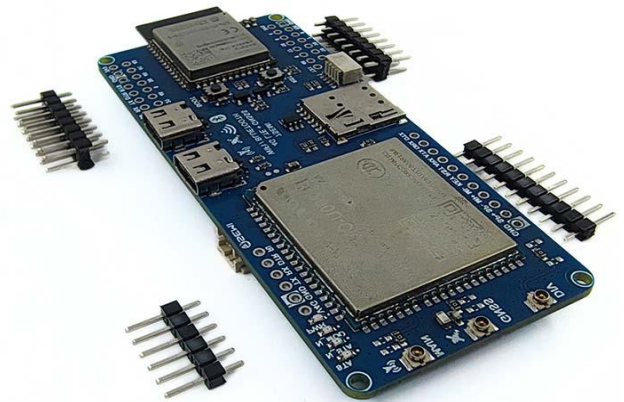
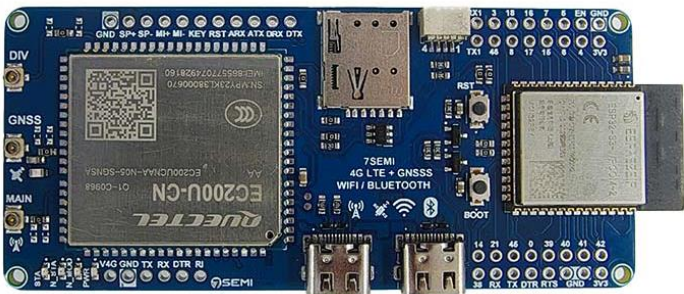

Table of Contents

1.0 Features	3
2.0 Description.....	7
2.1 7Semi ESP32-S3 EC200U 4G Board	8
3.0 Pinouts	9
4.0 Example connection of 7Semi ESP32-S3 EC200U 4G Board	10
4.1 Connection Explain of 7Semi ESP32-S3 EC200U 4G Connected to Audio Amplifier and Speaker for Calling	10
4.2 Connection Explain of 7Semi ESP32-S3 EC200U 4G Board Connected and retrieve GPS data to send an SMS containing a Google Maps link	14
5.0 Contact Information	19



Table of Figures

1.0 Features	3
2.0 Description.....	7
2.1 7Semi ESP32-S3 EC200U 4G Board	8
2.1.1 Bottom view.....	8
2.1.2 Side view.....	8
2.1.3 Top view.....	8
3.0 Pinouts	9
3.1 Pinouts.....	9
4.0 Example connection of 7Semi ESP32-S3 EC200U 4G Board	10
4.1.1 Circuit diagram	10
4.2.1 Serial Monitor	17
4.2.2 Output SMS	17
4.2.3 Google map view	18
5.0 Contact Information	19

1.0 Features

1. EC200U Series Module

Power Supply:

- Supply Voltage: 3.3–4.3 V.
- Typical Supply Voltage: 3.8 V.

Transmitting Power:

- Class 4 for EGSM850 and EGSM900.
- Class 1 for DCS1800 and PCS1900.
- Class 3 for LTE-FDD and LTE-TDD bands.

LTE Features:

- Supports Cat 1 FDD and TDD.
- RF Bandwidth: 1.4/3/5/10/15/20 MHz.
- FDD Data Rates: Max. 10 Mbps (DL) and Max. 5 Mbps (UL).
- TDD Data Rates: Max. 8.96 Mbps (DL) and Max. 3.1 Mbps (UL).

GSM Features:

- GPRS multi-slot class 12.
- Coding Schemes: CS-1 to CS-4.
- Max Data Rates: 85.6 kbps (DL and UL).

Internet Protocol Features:

- Supported Protocols: TCP, UDP, PPP, NTP, NITZ, FTP, HTTP, PING, CMUX, HTTPS, FTPS, SSL, FILE, MQTT, MMS.
- Authentication: PAP and CHAP for PPP connections.

SMS Features:

- Text and PDU modes.
- Point-to-Point MO and MT.
- Cell Broadcast.
- Storage: Stored in (U)SIM card and ME (default in ME).

SIM Interface:

- Supports 1.8/3.0 V SIM.
- Supports DSDS (Dual SIM Dual Standby).

Audio Features:

- Supports one analog audio input and one analog audio output.
- Supports HR/FR/EFR/AMR/AMR-WB.
- Features echo cancellation and noise suppression.

USB Interface:

- Compliant with USB 2.0 (slave mode only); data transfer rate up to 480 Mbps.
- Used for AT command communication, data transmission, software debugging, firmware upgrade.
- Supports USB serial drivers for Windows 7/8/8.1/10, Linux 2.6–5.12, and Android 4.x–11.x.

UART Interfaces:

- Main UART: Used for AT command communication, baud rate up to 921600 bps, supports hardware flow control.
- Debug UART: For Linux console and log output, baud rate 921600 bps.
- Auxiliary UART.

I2C Interfaces:

- Two I2C interfaces.

SPI Interface:

- Supports master mode only.

SD Card Interface:

- SD 2.0 protocol compliant.

WLAN Application Interface:

- Supports SDIO 1.1 interface for WLAN functionality.

USB_BOOT Interface:

- Forced download interface.

AT Commands:

- Compliant with 3GPP TS 27.007, 3GPP TS 27.005, and Quectel enhanced AT commands

Network Indication:

- NET_MODE and NET_STATUS for network connectivity indication.

Antenna Interfaces:

- Main antenna (ANT_MAIN).
- Wi-Fi/Bluetooth antenna (ANT_BT/WIFI_SCAN).
- GNSS antenna (ANT_GNSS).

Location Support:

- Supports Wi-Fi Scan and GNSS.

Physical Characteristics:

- Size: 28.0 mm × 31.0 mm × 2.4 mm.
- Weight: Approx. 4.1 g.

Temperature Ranges:

- Operating Temperature: -35 °C to +75 °C.
- Extended Temperature: -40 °C to +85 °C.
- Storage Temperature: -40 °C to +90 °C.

Firmware Upgrade:

- Via USB interface or FOTA (Firmware Over-The-Air).

RoHS Compliance:

- Fully compliant with EU RoHS directive.

2. ESP 32

Wi-Fi:

- Supports 802.11b/g/n (2.4 GHz), up to 150 Mbps.
- WMM, Antenna Diversity, and Simultaneous Station/SoftAP modes.

Bluetooth:

- Bluetooth v4.2 (BR/EDR and BLE).
- Up to +9 dBm transmit power, -94 dBm sensitivity.
- Supports multi-connections, audio codecs (CVSD, SBC).

CPU & Memory:

- Xtensa® LX6 dual-core (240 MHz), 520 KB SRAM, 448 KB ROM.
- QSPI for external flash/SRAM support.

Power Management:

- Power modes: Active, Modem-sleep, Light-sleep, Deep-sleep, Hibernation.
- Deep-sleep mode uses 10 μ A.

Peripherals:

- 34 GPIOs, 12-bit ADC (18 channels), SPI, I2C, I2S, UART, PWM, CAN.
- Ethernet MAC, SDIO, and Touch Sensors.

Security:

- Secure Boot, Flash Encryption, AES, RSA, ECC.

2.0 Description

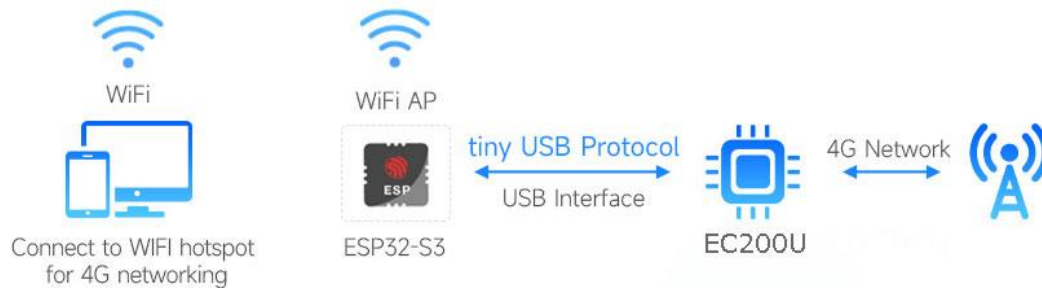

This **7Semi ESP32-S3 EC200U 4G** integrates both the EC200U LTE module and the ESP32 Wi-Fi/Bluetooth microcontroller on a single platform, offering a powerful solution for IoT and communication-based applications.

- **EC200U Module:** A 4G LTE Cat 1 modem, providing cellular communication with support for GPS/GNSS, enabling long-distance data transmission and location tracking. It offers high-speed internet over LTE networks and supports fallback to GSM, making it versatile for different regions and network conditions. The EC200U module also supports multiple communication protocols like TCP/IP, FTP, and MQTT, suitable for IoT deployments.
- **ESP32 Module:** A highly integrated SoC that features both Wi-Fi and Bluetooth connectivity. It acts as a local processing unit, managing real-time control tasks and wireless communication. With dual-core processing, the ESP32 handles various tasks, including sensor data management, local network communication, and Bluetooth device connectivity. Its robust peripheral set includes GPIOs, ADCs, PWMs, and communication interfaces like UART, SPI, and I2C.

Combined Features:

- **Seamless Communication:** The EC200U and ESP32 communicate effectively through UART, allowing control of cellular functions (like SMS, internet access) from the ESP32 without external wiring.
- **Dual Connectivity:** Provides LTE-based long-range communication via the EC200U, while offering short-range Wi-Fi and Bluetooth connectivity via the ESP32.
- **Power Management:** Both modules are optimized for low power consumption, making the board ideal for battery-powered IoT applications.
- **Peripheral Sharing:** The board allows shared use of peripherals like antennas and communication buses, optimizing design space and performance.

This integrated board is ideal for IoT, industrial automation, GPS tracking, and remote data monitoring applications.

2.1 7Semi ESP32-S3 EC200U 4G Board

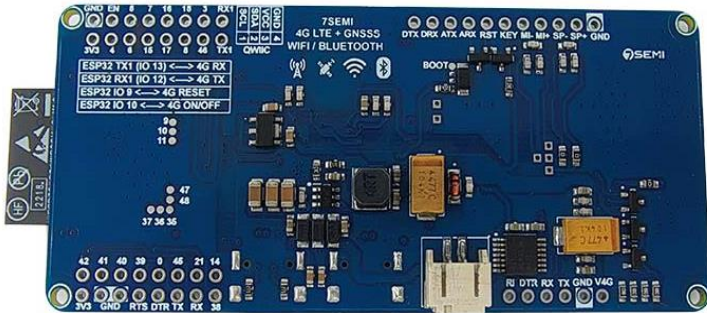

Figure 2.1.1 Bottom view

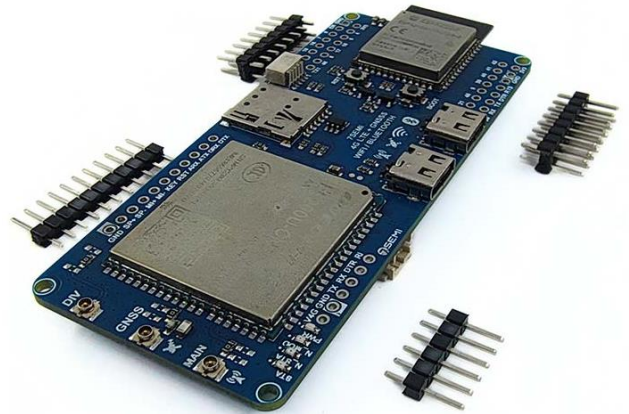

Figure 2.1.2 Side view

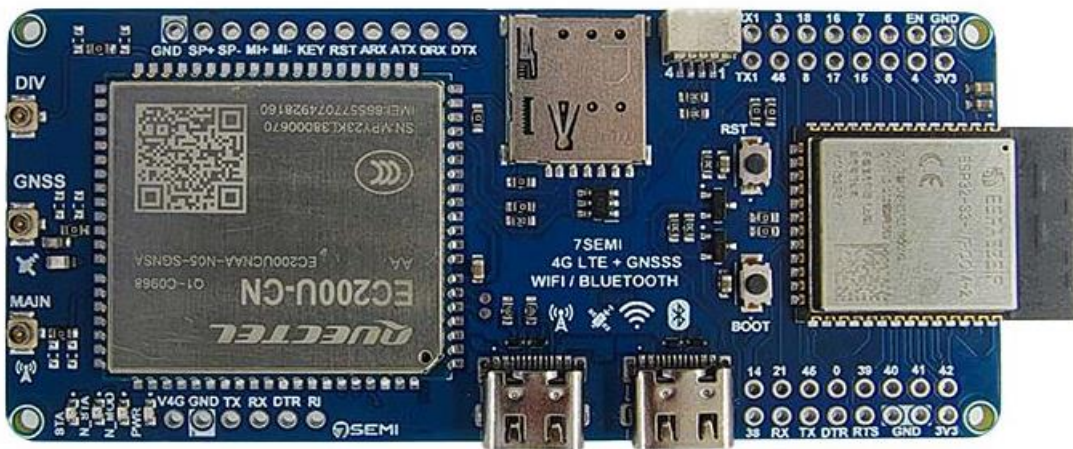

Figure 2.1.3 Top view

3.0 Pinouts

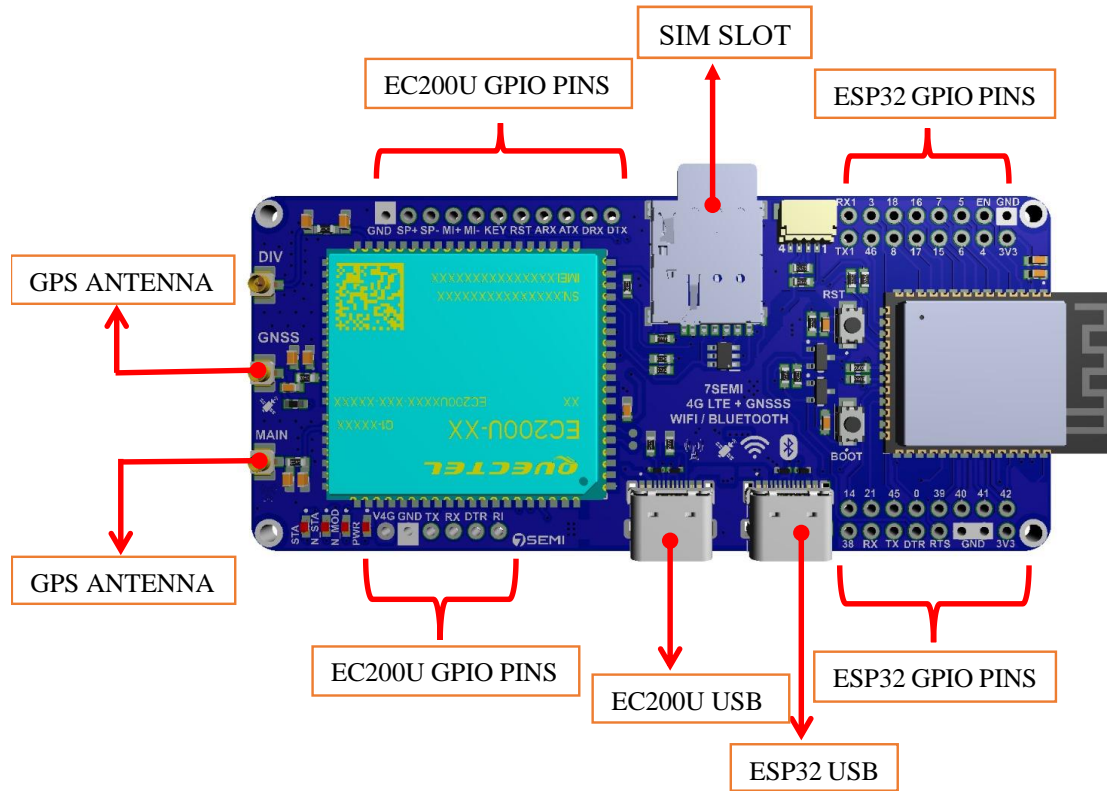

Figure 3.1 Pinouts

4.0 Example connection of 7Semi ESP32-S3 EC200U 4G Board

4.1 Connection Explain of 7Semi ESP32-S3 EC200U 4G Connected to Audio Amplifier and Speaker for Calling

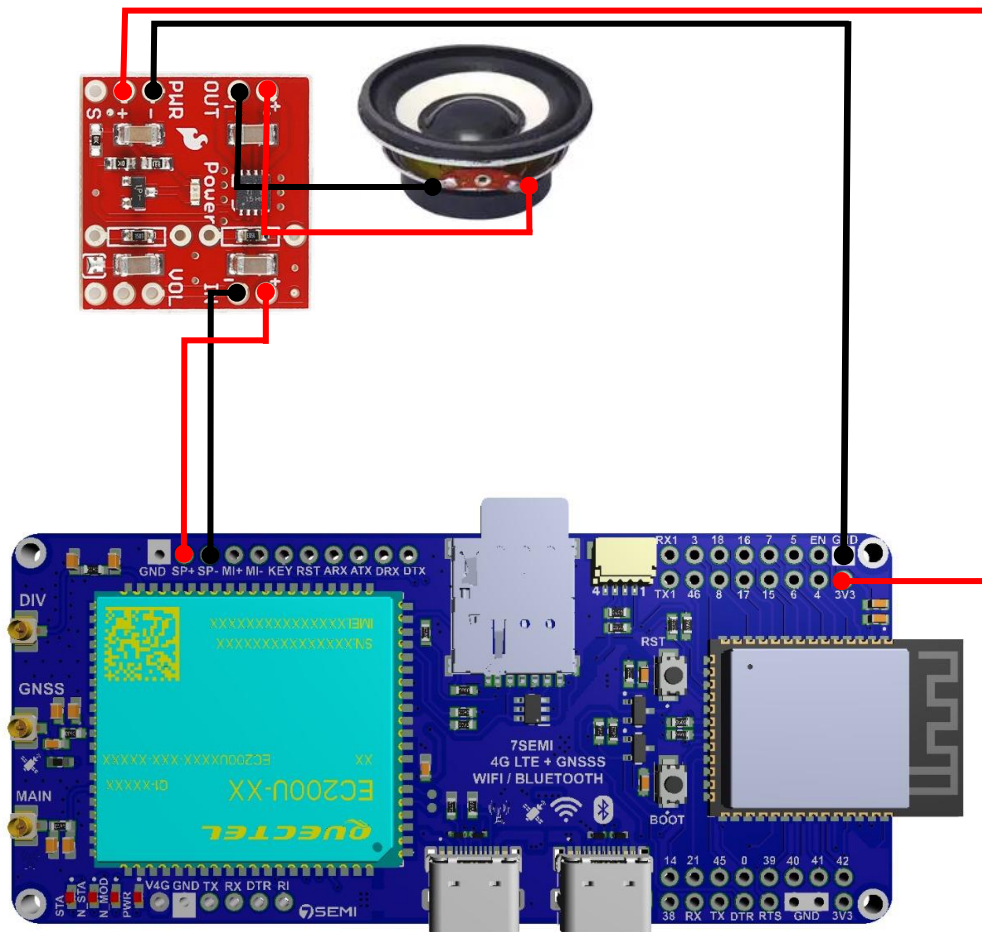

Figure 4.1.1 Circuit diagram

In this setup, the 7Semi ESP32-S3 EC200U 4G modules are integrated on the same board, with the EC200U module responsible for managing cellular communication, while the ESP32 manages processing tasks and peripheral control. Here's how you can connect the board to an audio amplifier and speaker for voice calling functionality using AT commands:

Components Involved:

1. **7Semi EC200U Module:** Responsible for LTE communication and voice calling.
2. **ESP32 Module:** Acts as the controller to issue AT commands to the EC200U.
3. **Audio Amplifier:** Amplifies the audio signal from the EC200U for the speaker.
4. **Speaker:** Outputs the audio during a call.
5. **Microphone (optional):** For voice input during calls.
6. **SIM Card:** Inserted in the EC200U's SIM slot for cellular network access.

Connection Overview:

1. **ESP32 to EC200U:**
 - **UART Interface:** The ESP32 communicates with the EC200U using UART (RX/TX). This allows the ESP32 to send AT commands for making calls, sending SMS, and managing data over LTE.
 - **Power Supply:** Ensure both modules share the correct voltage supply (3.3V or 3.8V for the EC200U as specified)(EC200U PINOUT).
2. **EC200U to Audio Amplifier:**
 - The EC200U has **audio input/output (analog)** pins that can be connected to the amplifier. These are used to transmit the voice signals during a call.
 - **Amplifier:** Connect the audio output from the EC200U to the amplifier's input.
 - **Speaker:** The amplifier's output is then connected to the speaker for audio playback.
3. **ESP32 Control:**
 - The ESP32 sends **AT commands** to the EC200U to initiate, answer, or end calls. These commands can also control volume and speaker functions.

Example AT Commands for Calling:

- **Initiating a Call:**

```
ATD+1234567890; // Dials the number 1234567890
```

- **Answering a Call:**

ATA // Answers an incoming call

- **Hanging Up a Call:**

ATH // Ends the current call

- **Controlling Audio Output:** Use specific AT commands to route audio to the correct output (e.g., speaker), control volume, and manage audio settings during a call.

Additional Features:

- **Speaker Control:** The ESP32 can adjust the audio settings (volume, mute, etc.) by sending AT commands through the UART interface.
- **Microphone Integration:** If a microphone is integrated, the EC200U can handle both incoming and outgoing audio streams, enabling two-way voice communication.

This configuration provides a fully functional calling solution with audio playback through a speaker, controlled by the ESP32 module, which sends AT commands to the EC200U to manage the call.

Pin Connection Explanation for Amplifier and Speaker Setup:

1. SP+ and SP- (EC200U Audio Output):

- The **SP+** and **SP-** pins on the **EC200U module** provide the **analog audio output**. These pins are designed to carry the voice signal during a call.
- **SP+:** Carries the positive audio signal.
- **SP-:** Carries the negative (grounded) audio signal.

These audio signals need to be amplified to drive the speaker.

2. Connecting SP+ and SP- to the Amplifier Input:

- The **SP+** pin is connected to the **Input+** pin of the amplifier.
- The **SP-** pin is connected to the **Input-** pin of the amplifier.

This configuration allows the amplifier to receive the differential audio signal from the EC200U module.

3. Speaker Connection to Amplifier Output:

- The speaker is connected to the **Output+** and **Output-** pins of the amplifier board:
- **Output+** from the amplifier goes to the **positive terminal** of the speaker.
- **Output-** from the amplifier goes to the **negative terminal** of the speaker.

The amplifier boosts the audio signal coming from the EC200U and drives the speaker for clear voice output during a call.

4. Powering the Amplifier:

- The amplifier requires a power supply, which should be connected to the **power input terminals** of the amplifier board.
- The required input voltage is typically specified by the amplifier board (e.g., 5V, 12V, depending on the amplifier's design).
- Make sure the input voltage is stable and within the range recommended by the amplifier manufacturer to avoid damage or poor performance.

Summary of Connections:

- **SP+** (EC200U) → **Input+** (Amplifier).
- **SP-** (EC200U) → **Input-** (Amplifier).
- **Output+** (Amplifier) → **Speaker +**.
- **Output-** (Amplifier) → **Speaker -**.
- **Power Supply:** Connect to the amplifier's power input for operation.

This setup ensures that the audio signal from the EC200U is amplified and output through the speaker for clear sound during a call.

4.2 Connection Explain of 7Semi ESP32-S3 EC200U 4G Board Connected and retrieve GPS data to send an SMS containing a Google Maps link

To connect the 7Semi ESP32-S3 EC200U 4G board and retrieve GPS data to send an SMS containing a Google Maps link, you'll need to set up proper wiring and software communication. Here's how the connection and communication work.

1. Connection Between 7Semi EC200U and ESP32

The ESP32 is a powerful microcontroller with built-in Wi-Fi and Bluetooth, while the 7Semi EC200U is a versatile GSM/4G module that includes GPS capabilities, making it a great choice for applications such as tracking or IoT projects.

Hardware Setup (Wiring)

You'll connect the EC200U module to the ESP32 using UART (hardware serial communication), powering both devices appropriately.

- **ESP32 Pin Configuration:**
 - **TX Pin** (ESP32 → EC200U): Use any of the available UART TX pins (e.g., GPIO 17).
 - **RX Pin** (EC200U → ESP32): Use a corresponding UART RX pin (e.g., GPIO 16).
 - **Power Supply (VCC and GND):**
 - Ensure the EC200U is powered correctly (typically 3.3V or 5V, depending on the module).
 - Connect **GND** from the ESP32 to the **GND** of the EC200U module to complete the circuit.

Typical Wiring Diagram

EC200U Pin	ESP32 Pin	Description
TX	RX (GPIO 16)	Transmit from EC200U
RX	TX (GPIO 17)	Receive from ESP32
GND	GND	Ground connection
VCC	5V (or 3.3V)	Power the module

- Ensure to match the logic levels if necessary. The ESP32 operates at 3.3V, so if the EC200U requires 5V, a **logic level converter** may be needed to avoid damage.

2. ESP32 and EC200U Communication

The ESP32 will communicate with the EC200U using AT commands via the UART interface. Here's an outline of how the system works to send an SMS with a Google Maps link based on GPS data:

1. **ESP32 Sends AT Commands:**
 - The ESP32 sends an AT command (`AT+QGPS=1`) to enable GPS on the EC200U.
 - Then, it requests GPS location data (`AT+QGPSLOC=2`).
2. **Retrieving GPS Data:**
 - The EC200U responds with the latitude and longitude coordinates.
 - The ESP32 parses this data, extracts the coordinates, and constructs a Google Maps URL like `https://maps.google.com/?q=latitude,longitude`.
3. **Sending SMS:**
 - The ESP32 sends an AT command (`AT+CMGS="recipient_number"`) to send an SMS.
 - It transmits the Google Maps URL as the message content.
 - The EC200U sends the SMS with the location link to the specified phone number.

3. Software Flow

In the ESP32 code, here is the sequence of operations:

- **Setup:**
 - Initialize the EC200U module using UART.
 - Set the SMS mode (text mode using `AT+CMGF=1`).
 - Enable GPS functionality (`AT+QGPS=1`).
 - **Main Loop:**
 - Request GPS location (`AT+QGPSLOC=2`).
 - Parse the response to extract latitude and longitude.
 - Construct the Google Maps URL with the coordinates.
 - Send the URL via SMS to a predefined phone number using `AT+CMGS`.
4. **Example Use Case** Imagine you have a vehicle or asset tracking system. The ESP32, connected to the EC200U module, retrieves GPS coordinates of the vehicle's location at regular intervals. The ESP32 processes these coordinates and sends them via SMS to a phone number. The recipient can click on the SMS link to see the vehicle's location in Google Maps in real time.

5. Power Considerations

- **EC200U Power Supply:** The EC200U module may require 5V, and you should ensure that the current is sufficient for cellular communication (especially when sending SMS).
- **ESP32 Power:** Power the ESP32 either via USB or a regulated 3.3V supply, ensuring it is stable.

6. AT Commands for Communication

- **AT:** Basic test command to check communication.
- **AT+CMGF=1:** Sets the module to SMS text mode.
- **AT+QGPS=1:** Enables the GPS receiver.
- **AT+QGPSLOC=2:** Requests the GPS location.
- **AT+CMGS:** Command to send an SMS message.

7. GPS and SMS Example

For instance, if the GPS data is retrieved as:

```
+QGPSLOC: 120615.0,28.6139,77.2090,0.0,0.0,141220,09
```

- The coordinates are 28.6139 (latitude) and 77.2090 (longitude), representing a location in New Delhi, India.
- The ESP32 constructs the URL: <https://maps.google.com/?q=28.6139,77.2090>.
- This URL is then sent via SMS.

8. Final Output

The recipient receives an SMS like:

```
Check location: https://maps.google.com/?q=28.6139,77.2090
```

Upon clicking the link, Google Maps opens, showing the precise location.

Output and Sample code link

- **Serial Monitor in Arduino IDE:**

```
Message (Enter to send message to 'Arduino Uno' on 'COM13')
AT Command: AT
AT Command Response: AT
OK

AT Command: AT+CMGF=1
AT Command Response: AT+CMGF=1,0
AT Command: AT+QCPS=1
AT Command Response: AT+QCPS=1,0,0,0,0,0,S**IROR: 504

RC200U module initialized successfully.
AT Command: AT+OGPSLOC=2
AT Command Response: AT+OGPSLOC,2,0,0,0,0,0,j,j
+OGPSLOC: 072651.000,19.05494,73.01702,1.4,59.5,3
GPS Data: AT+QCPS,j,j
+QCPSLOC: 072651.000,19.05494,73.01702,1.4,59.5,3
AT Command:
AT Command Response: AT+CMGS="https://maps.google.com/?q=19.05494,73.01705"
> https://maps.google.com/?q=19.05494,73.01705
SMS sent
```

Figure 4.2.1 Serial Monitor

- **SMS received in recipient's phone:**

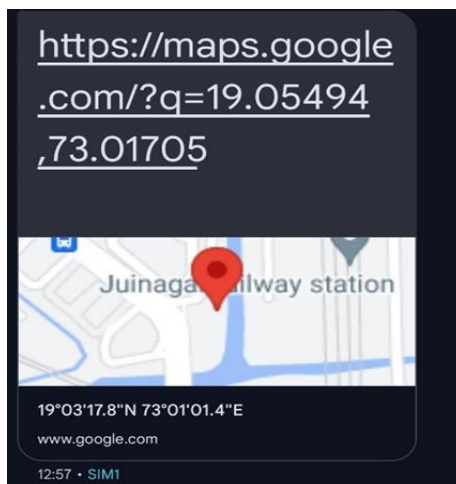

Figure 4.2.2 Output SMS

- **Clicking on the URL link redirects you to google maps:**

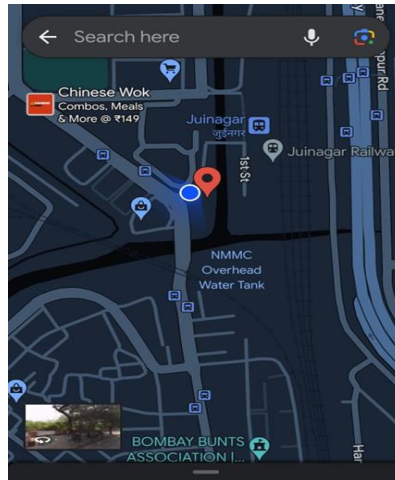

Figure 4.2.3 Google map view

- **Clicking on the URL link redirects you to google maps.**
- **Sample code link:- <https://shorturl.at/jFRel>**

AT Commands:

Refer to this link for all the AT Commands and Error codes while executing the code and make

changes accordingly,

Link :- <https://evelta.com/content/datasheets/EC200-GNSS-MANUAL.pdf>

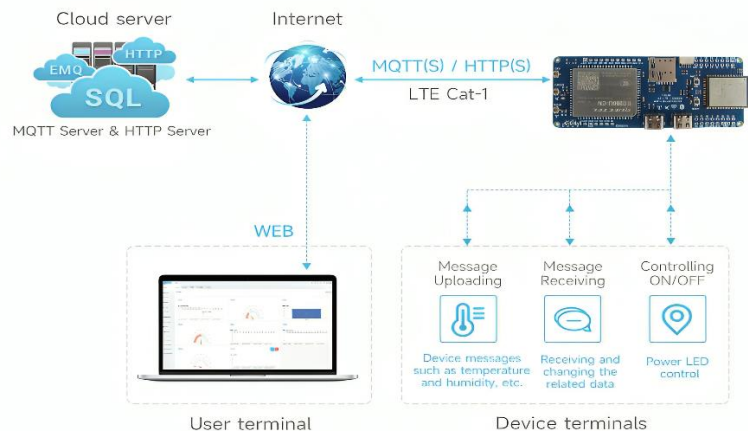

5.0 Contact Information



7Semi is a leading provider of wide range of efficient and accessible hardware products and related technical solutions to an extensive range of industries like IoT, Automation, Education and Learning, Robotics and more

Call us at : +91 8655821342

Email us at : info@7semi.com

We're happy to answer questions.

If you need assistance – [Click here to know more](#)